

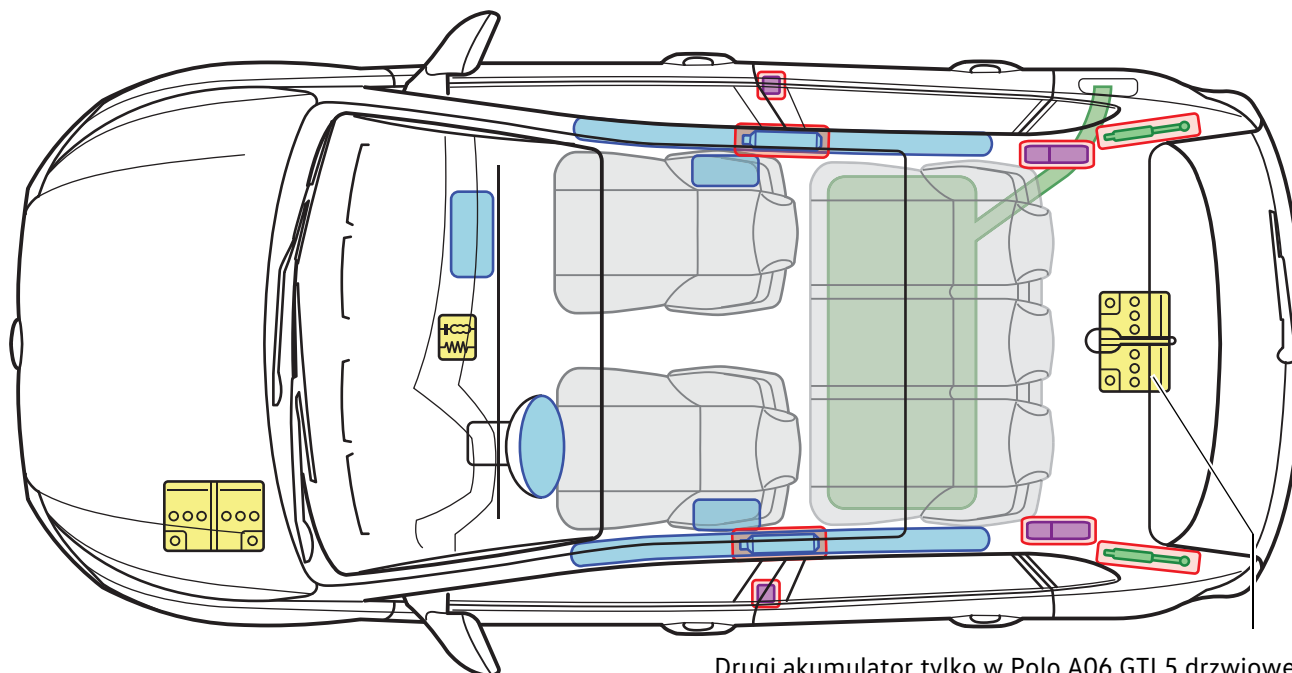

Polo A06







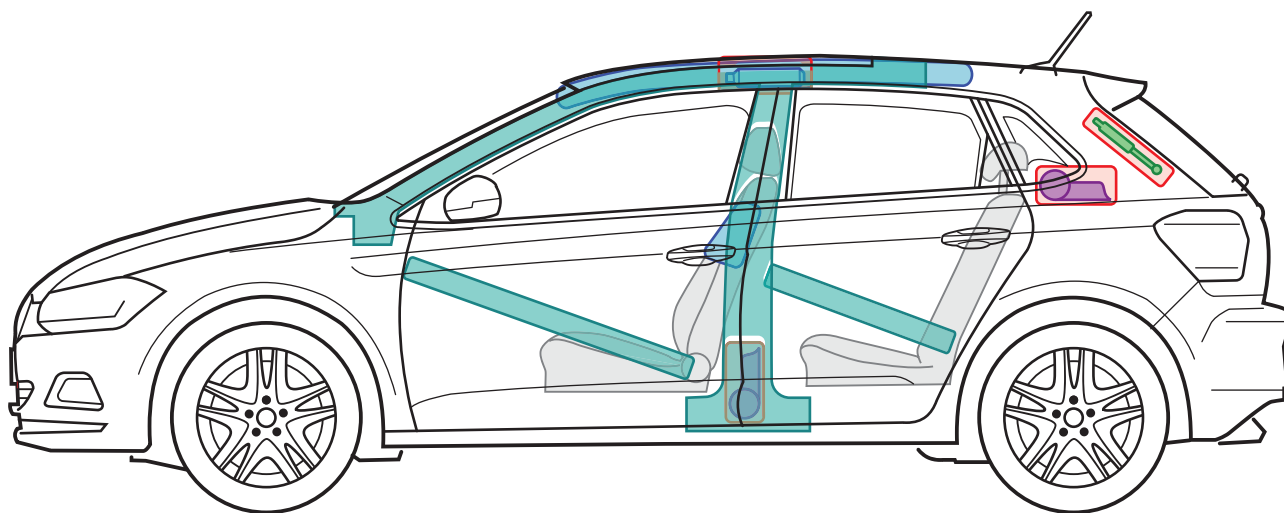

(5-drzwiowe, od 2017)



Drugi akumulator tyko w Polo A06 GTI 5 drzwiowe



Legenda

	Poduszka powietrzna		Wzmocnienie nadwozia		Sterownik
	Generator gazu				Akumulator 12 V
	Napinacz pasa bezpieczeństwa		Sprężyna gazowa		Zbiornik paliwa